

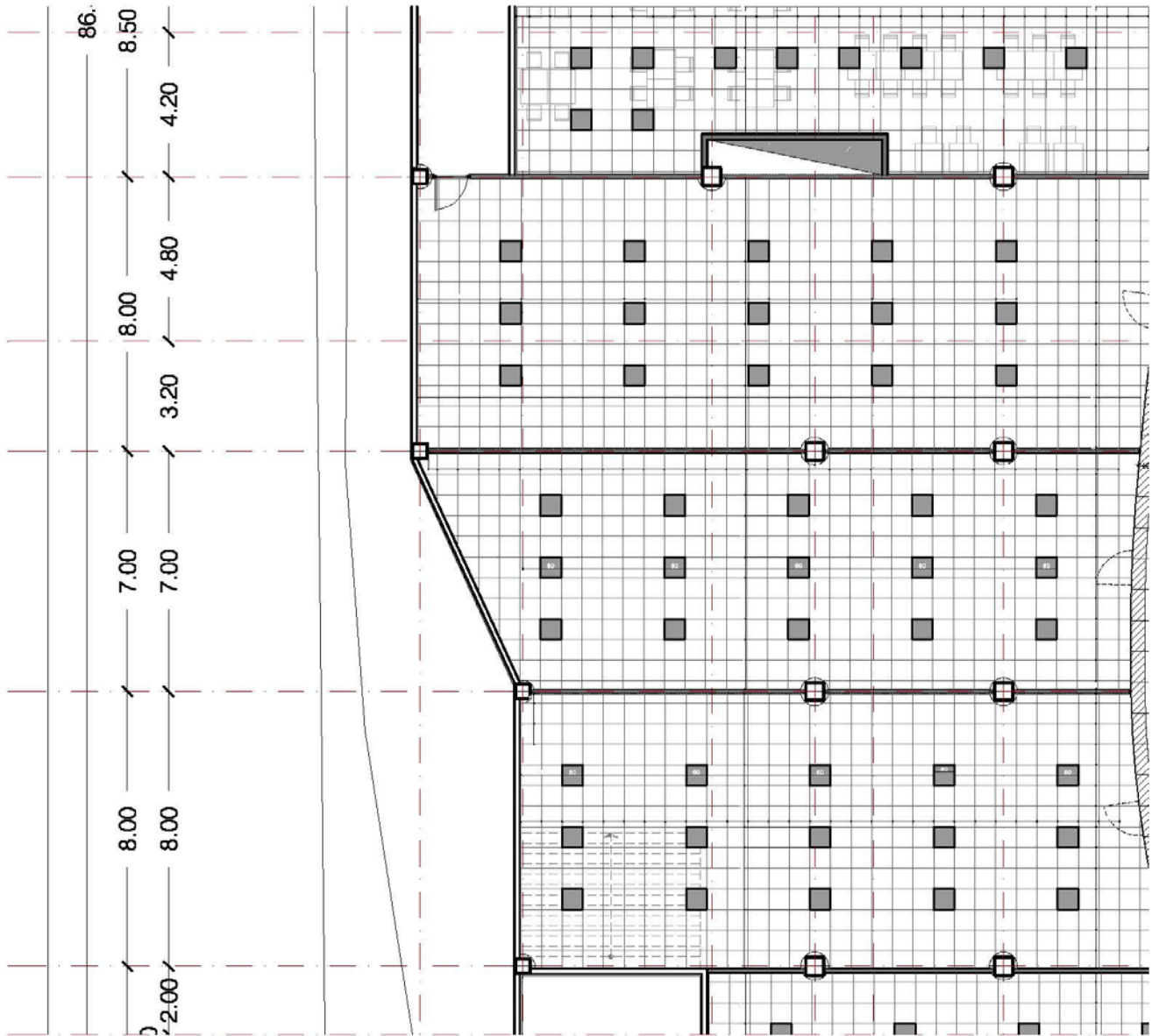

نمونه نقشه های فاز دو معماری

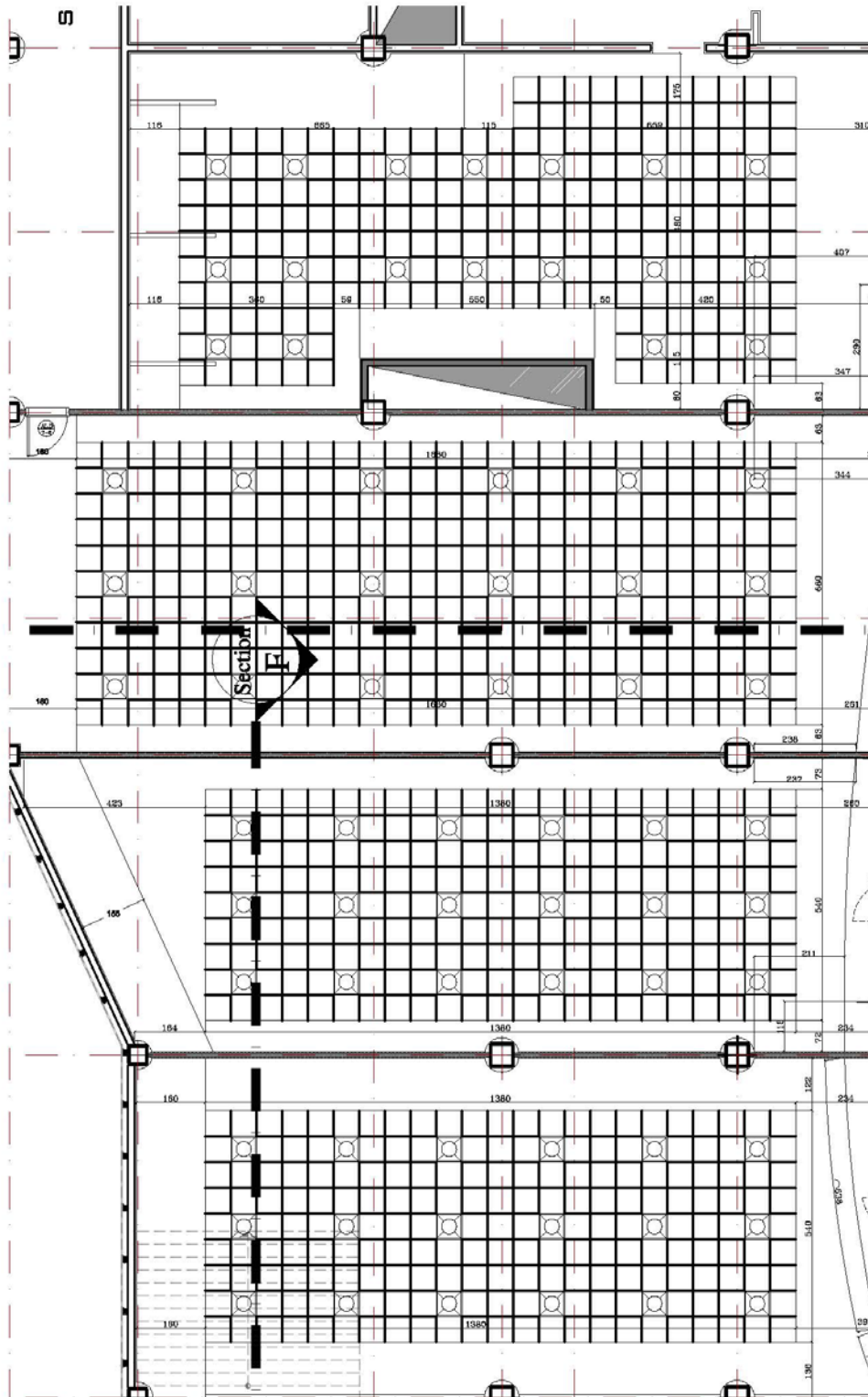

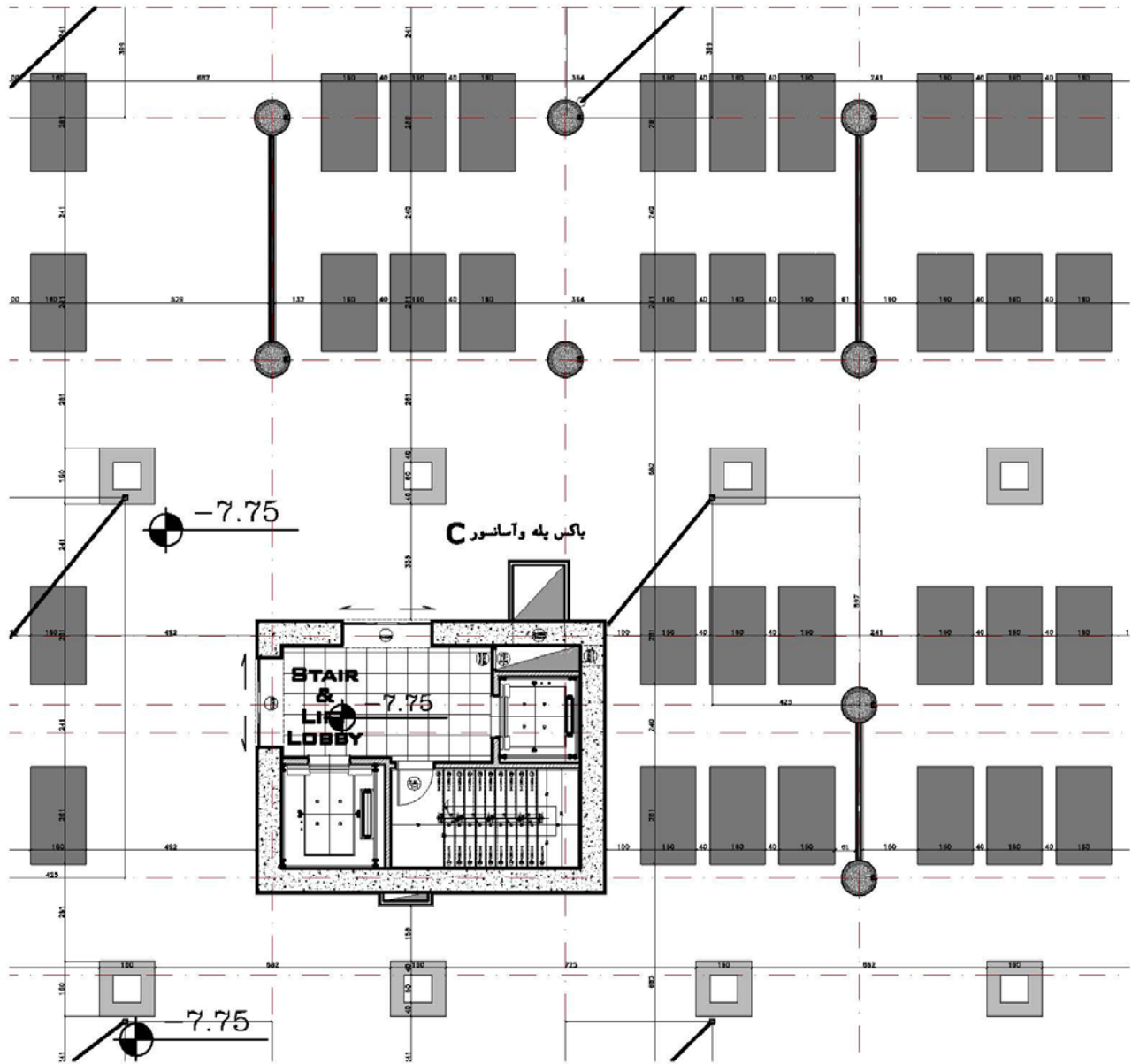



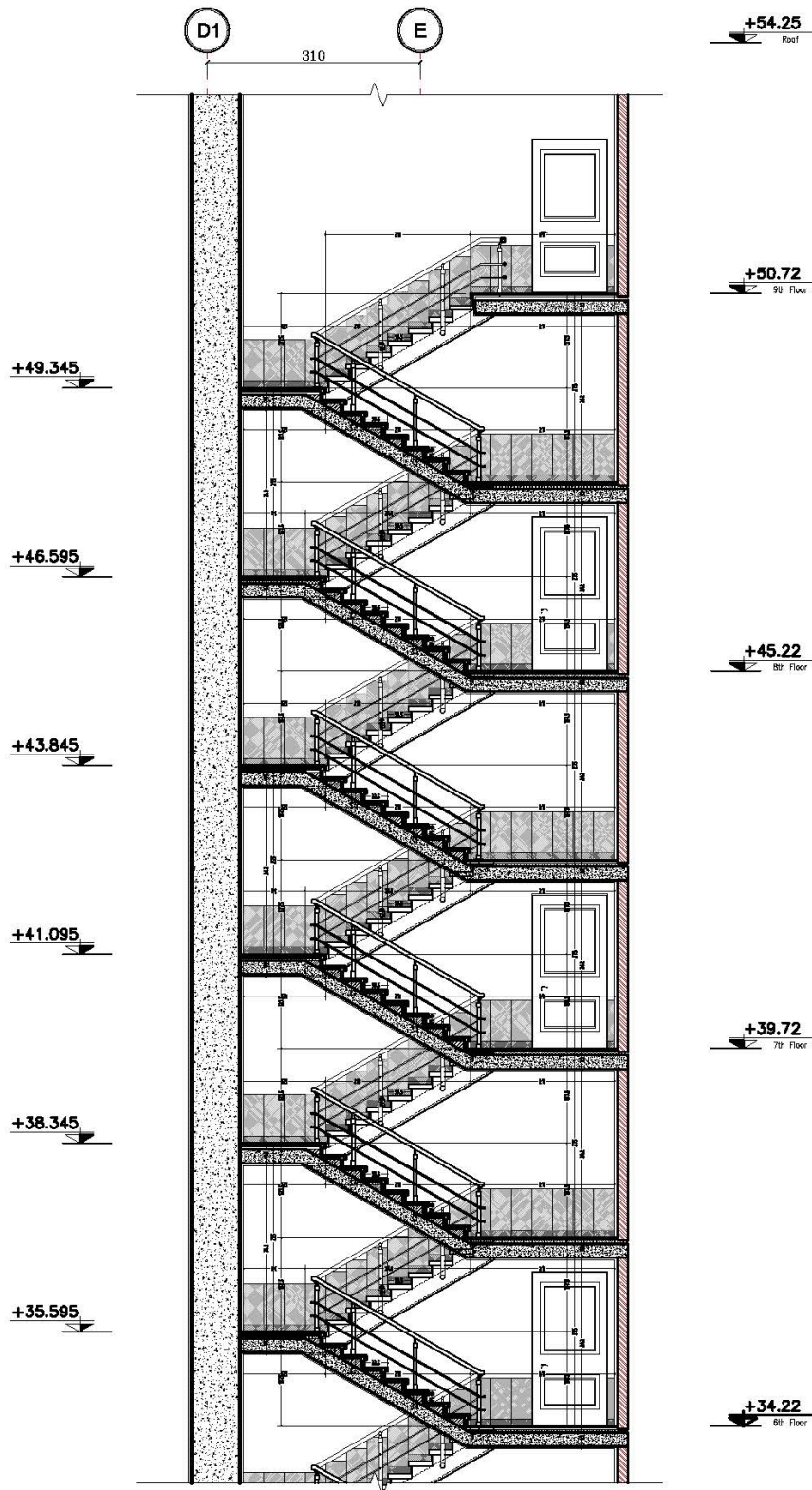

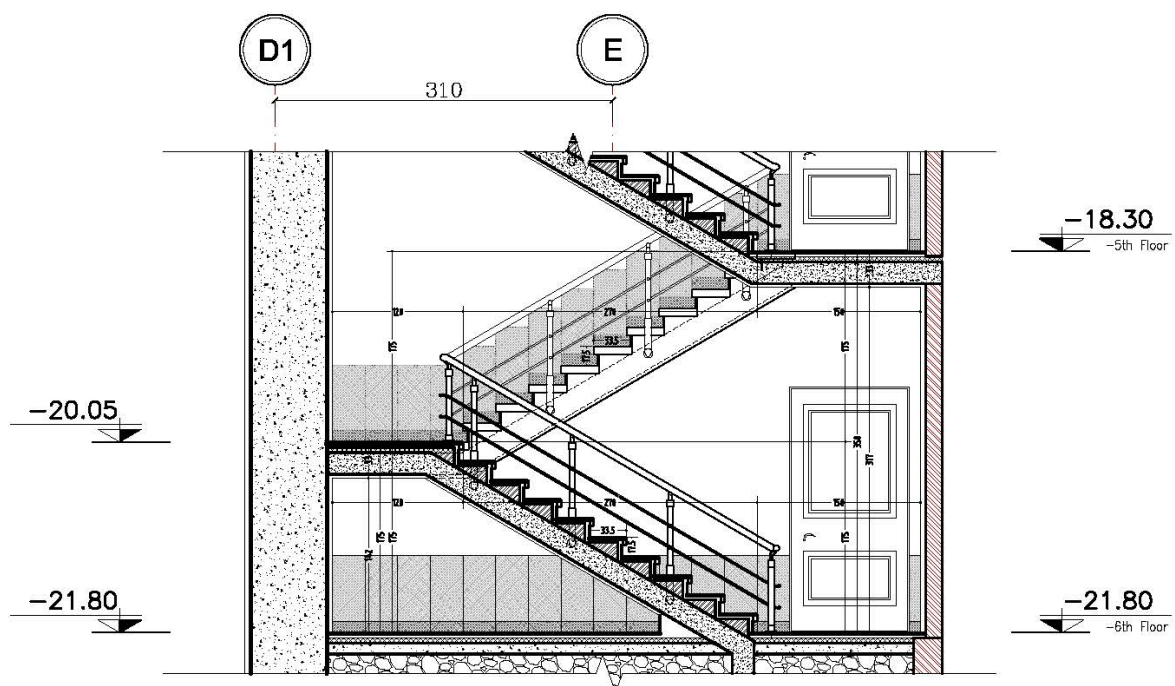
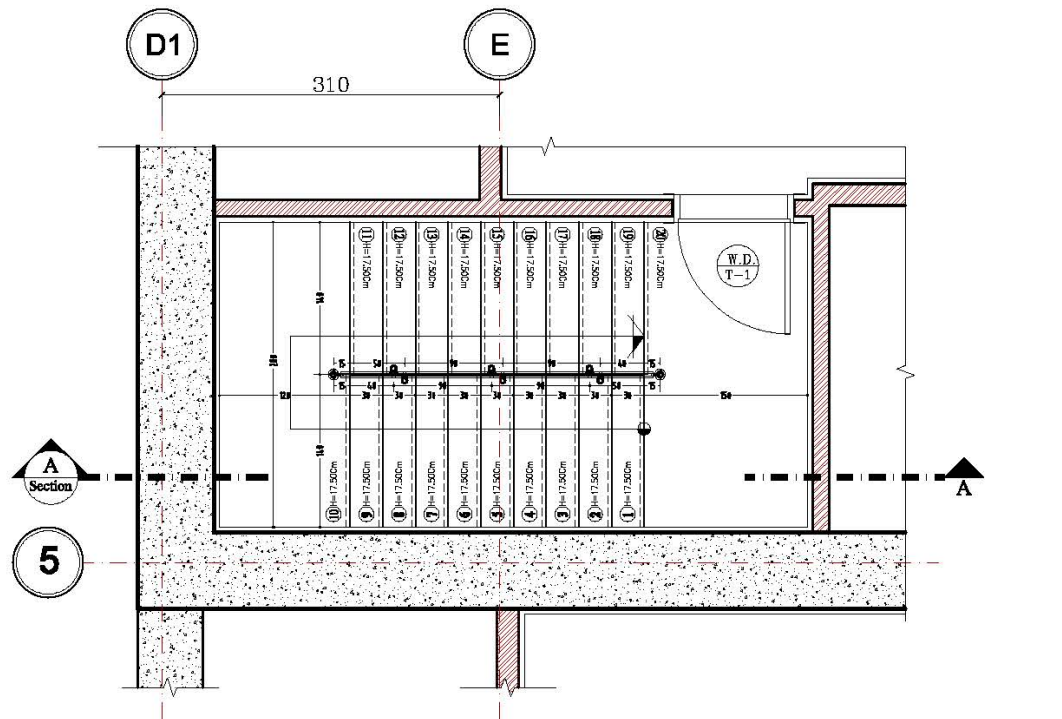

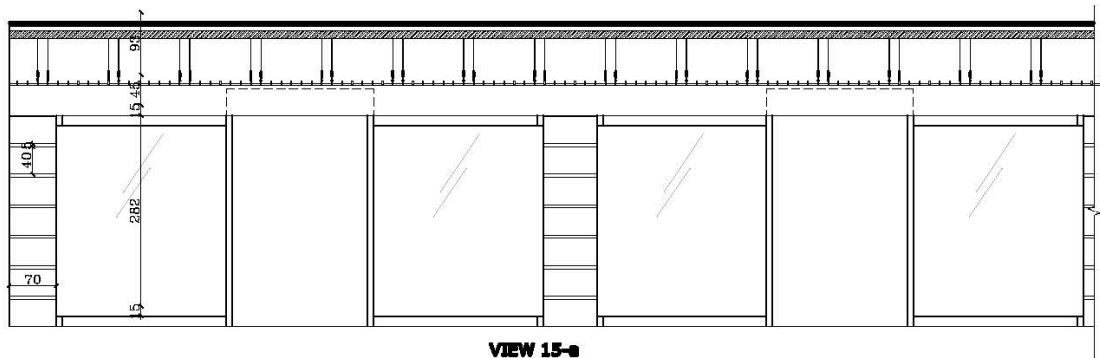

VIEW 15-a

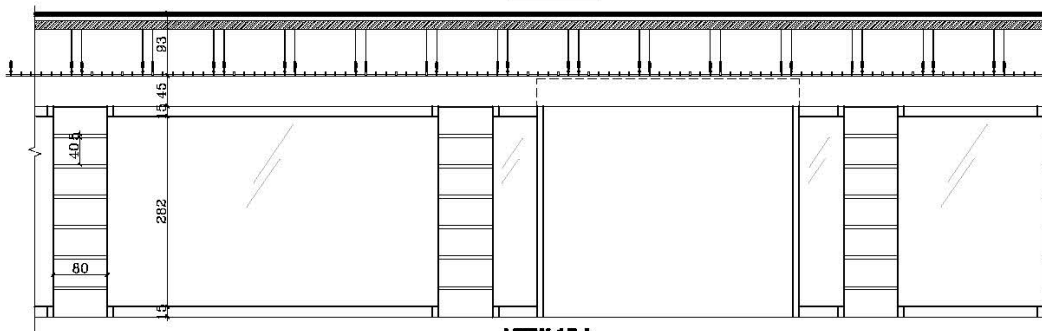

VIEW 15-b

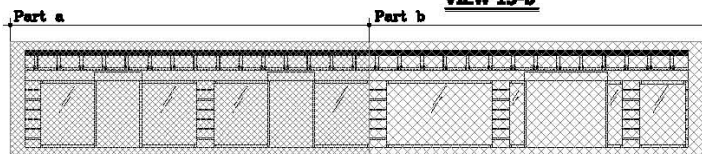

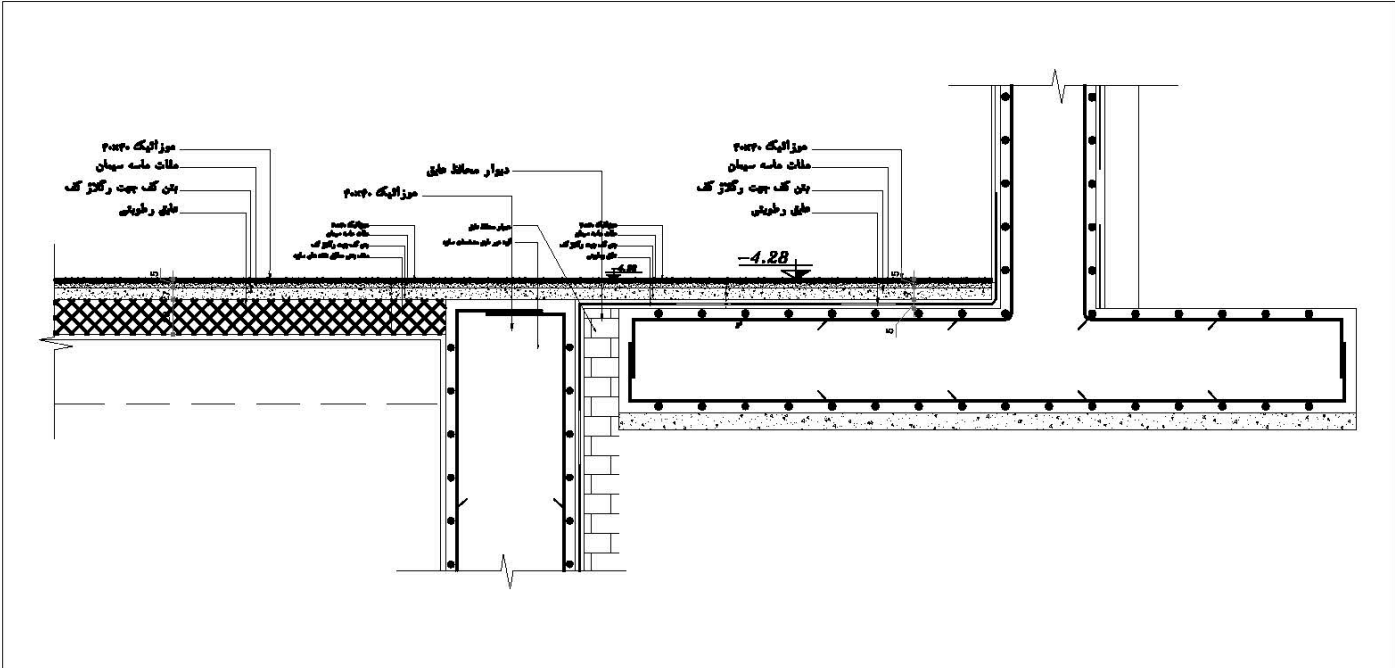

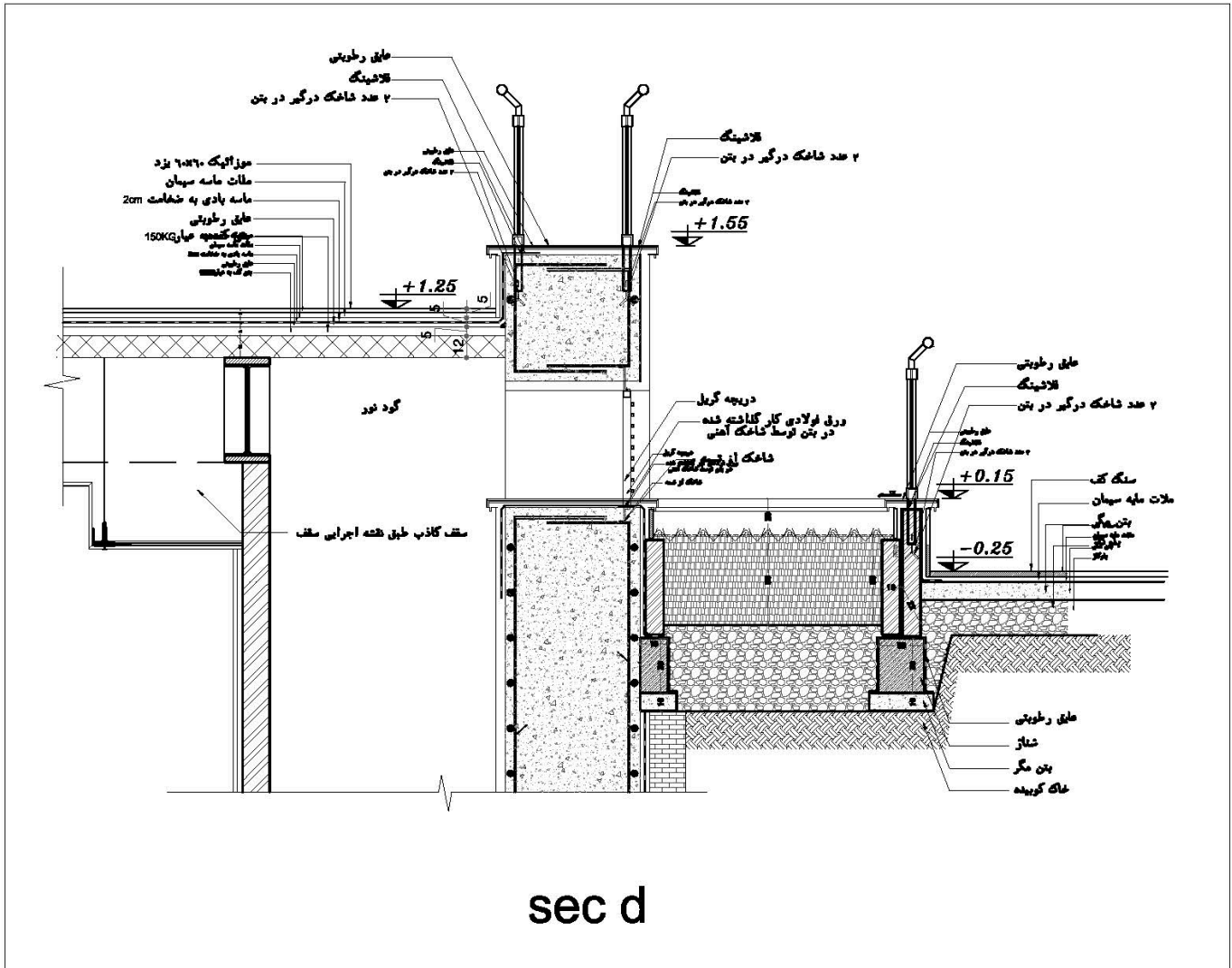

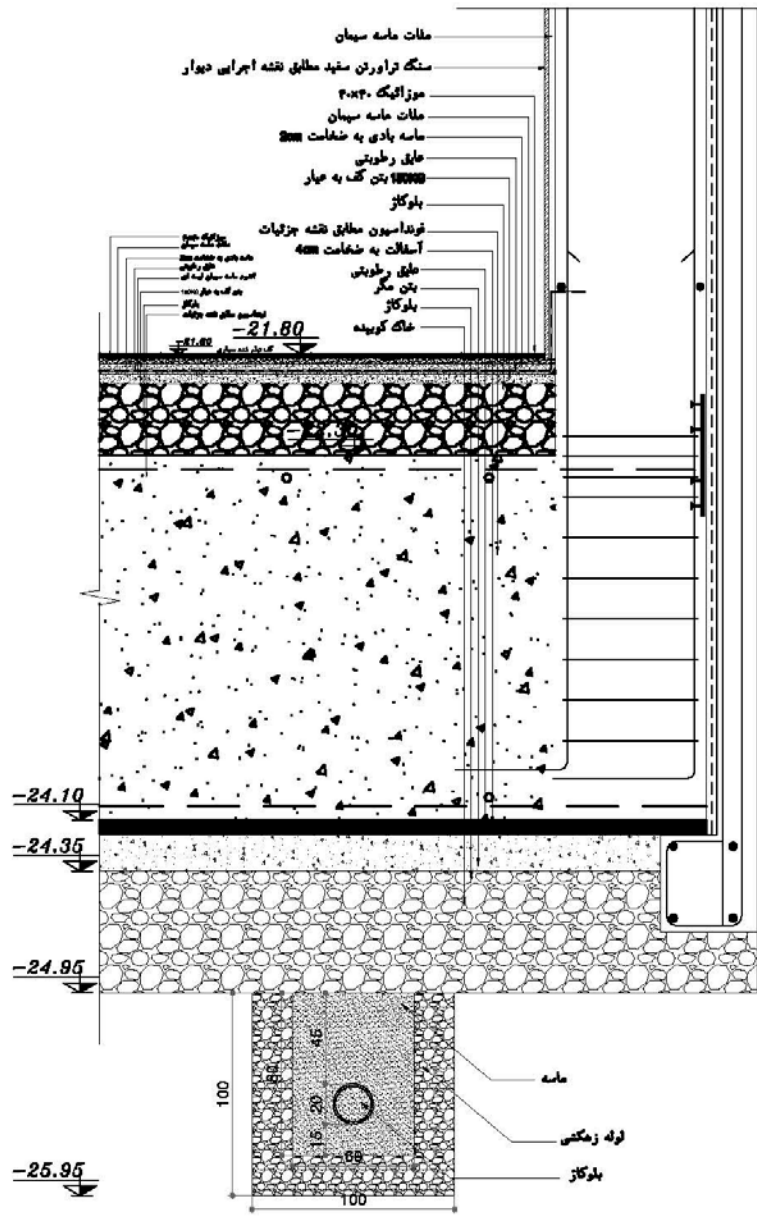

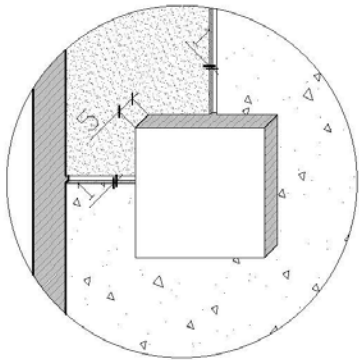
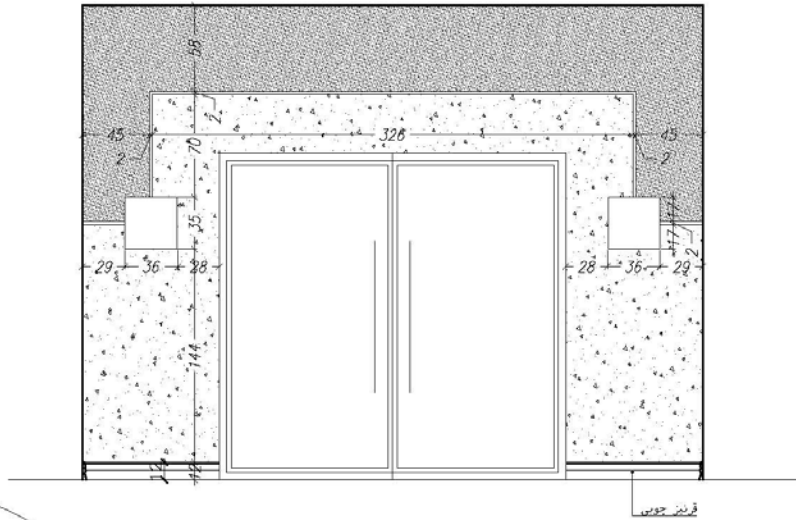



- کافه دیواری نوع A 
- کافه دیواری نوع B 
- رنگ روغنی مات 

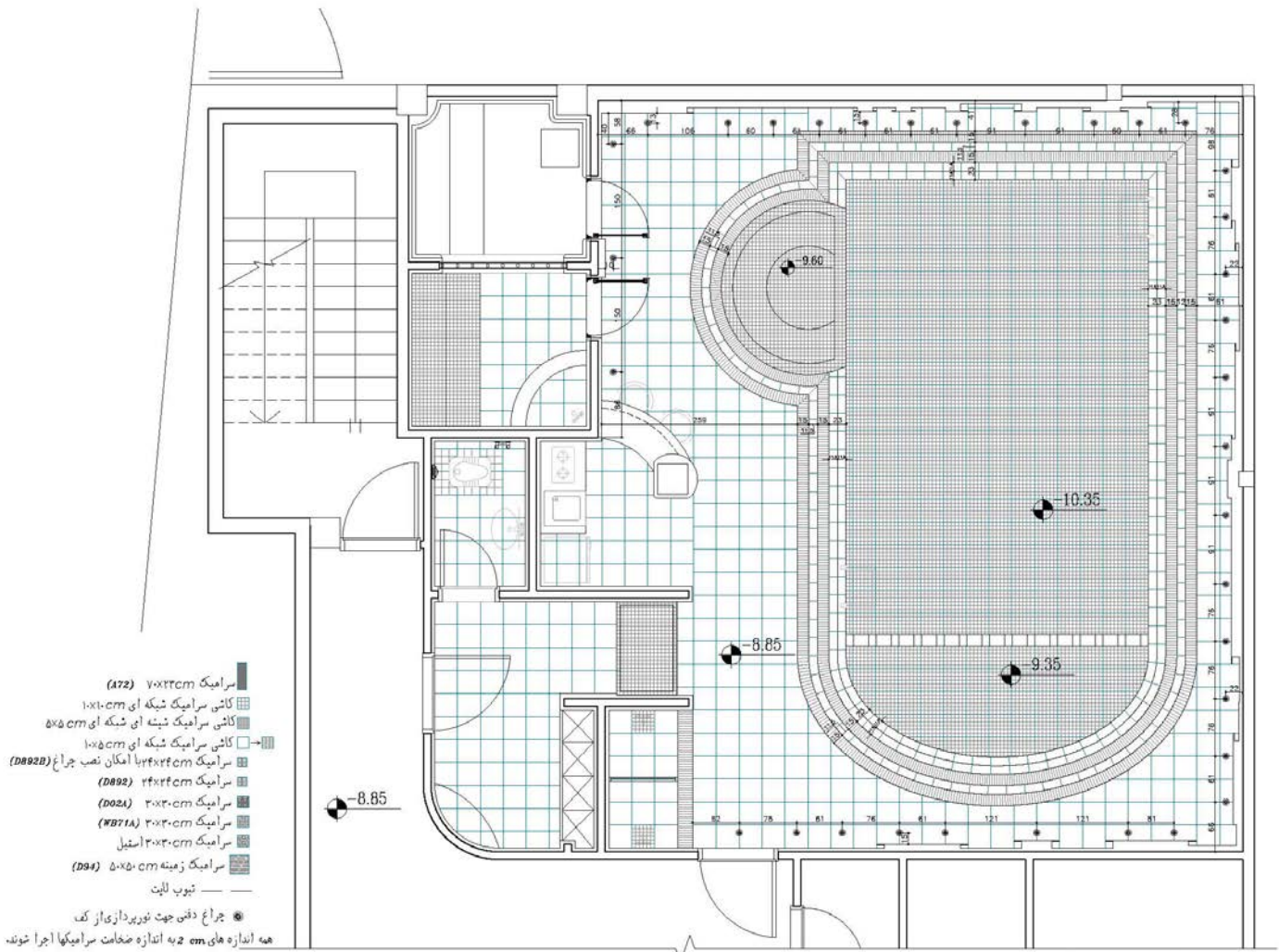

پلان سرامیک بندی و جانمایی چراغهای کف استخر

Sc:1/50

* 3 میلیمتر بند کفی برای سرامیکهای 30x30 اجرا شود.

* در کلیه شیت ها تغییر رنگ سرامیکها در سطوحی که کد ندارند بدون اختلاف سطح میباشد.

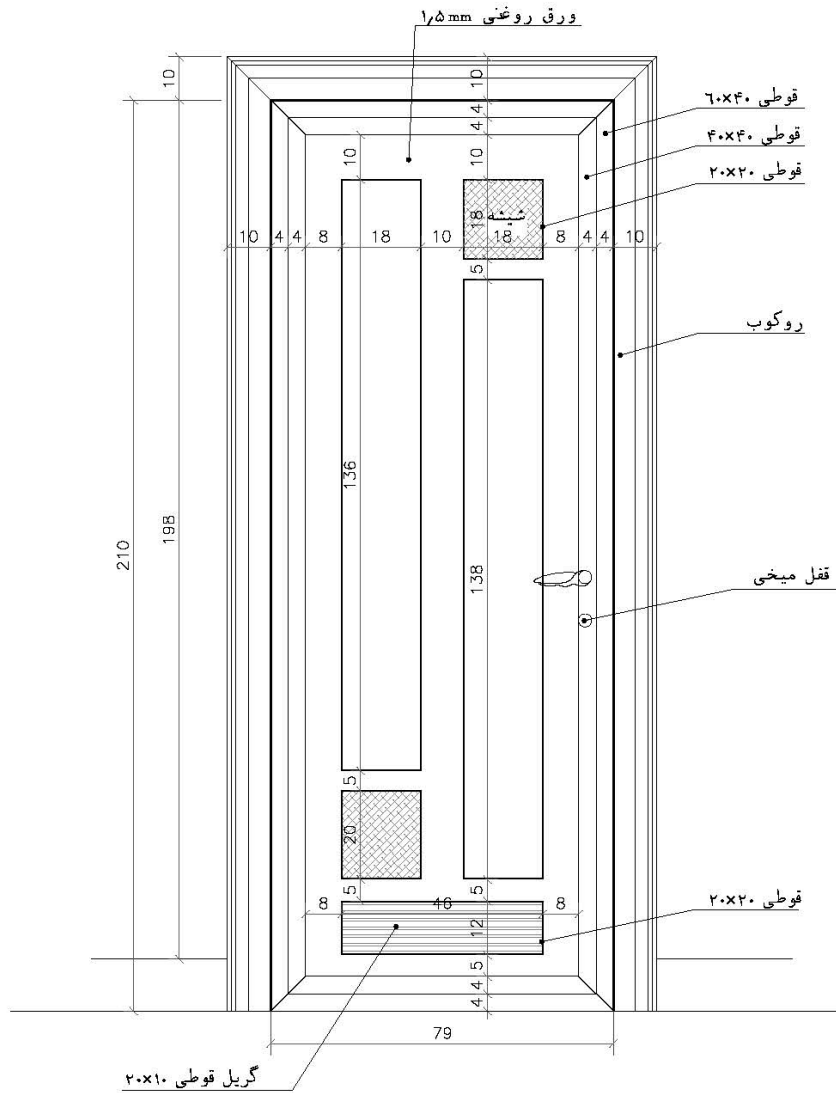

تیپ درهای انباری

Sc. 1:20

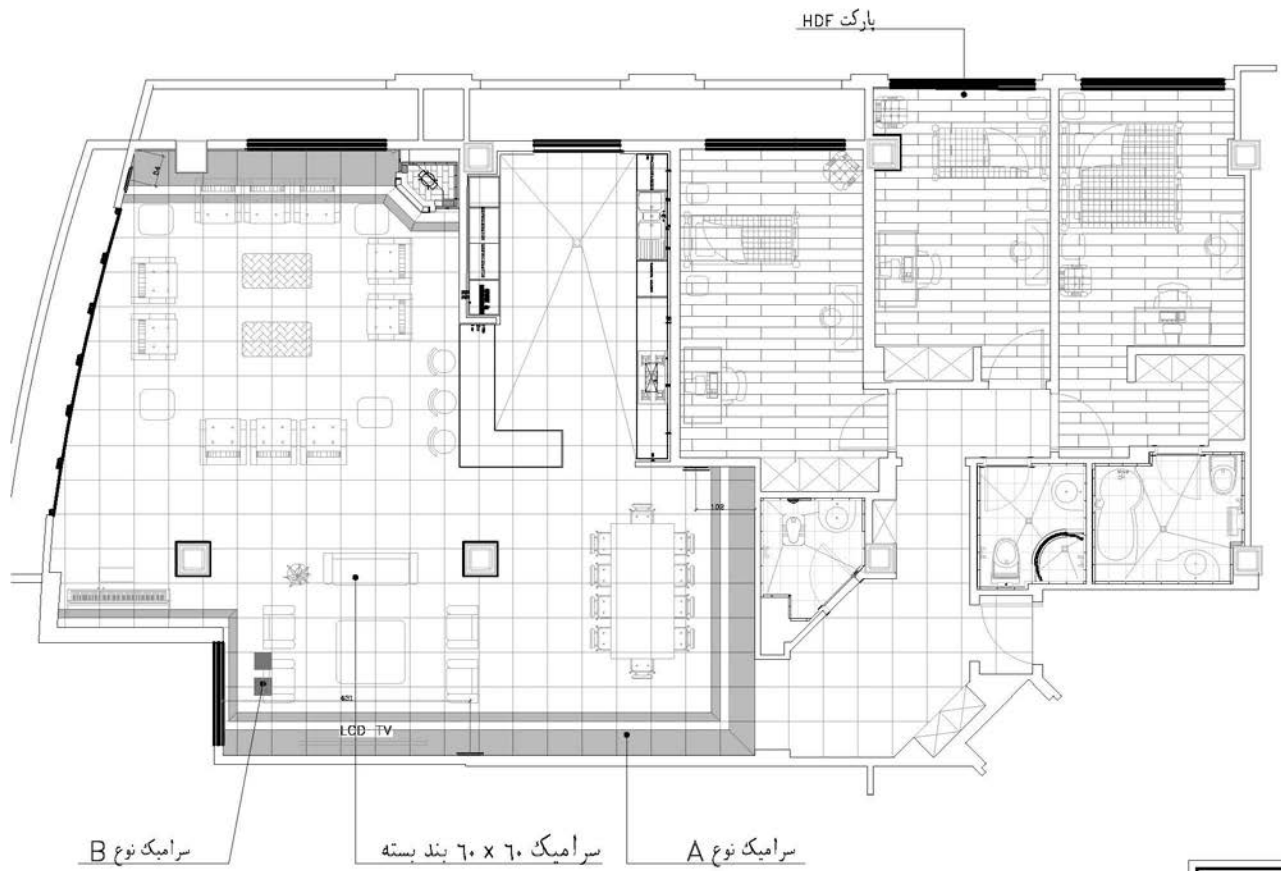

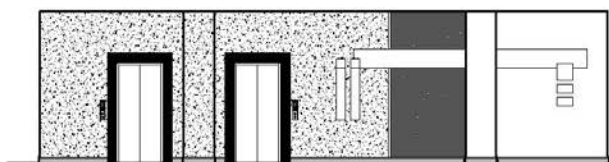
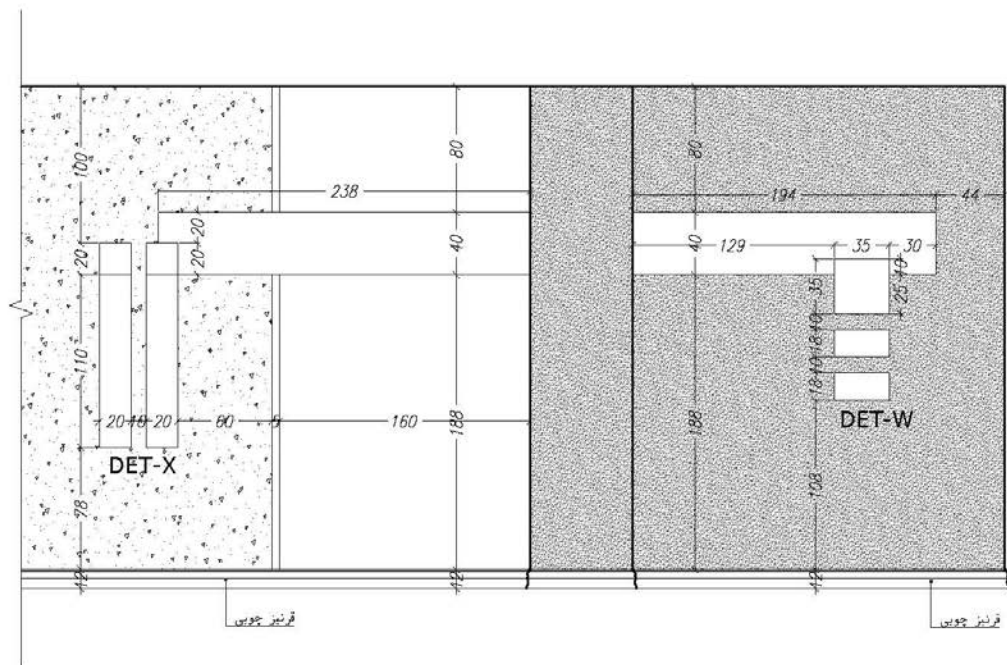

- کافه دیواری نوع A
- کافه دیواری نوع B
- رنگ روغنی مات

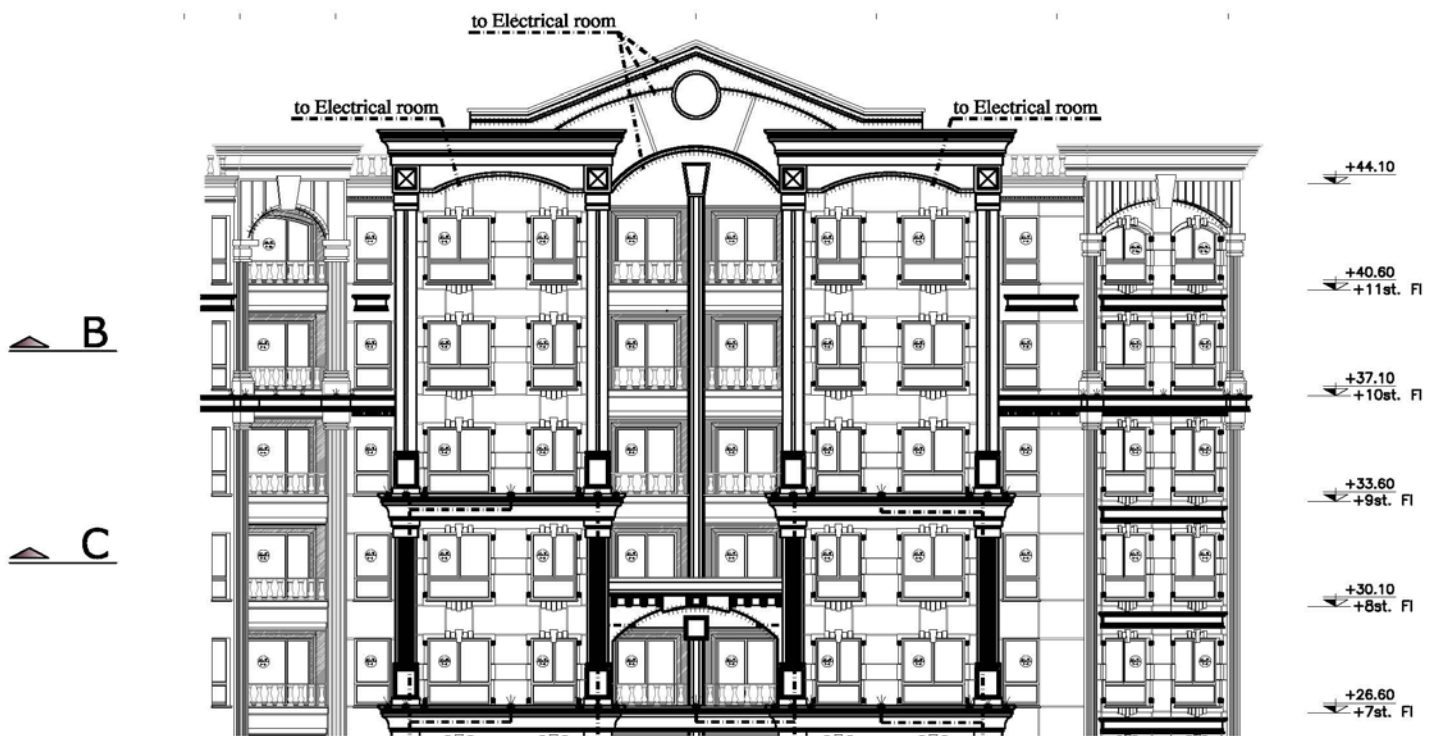

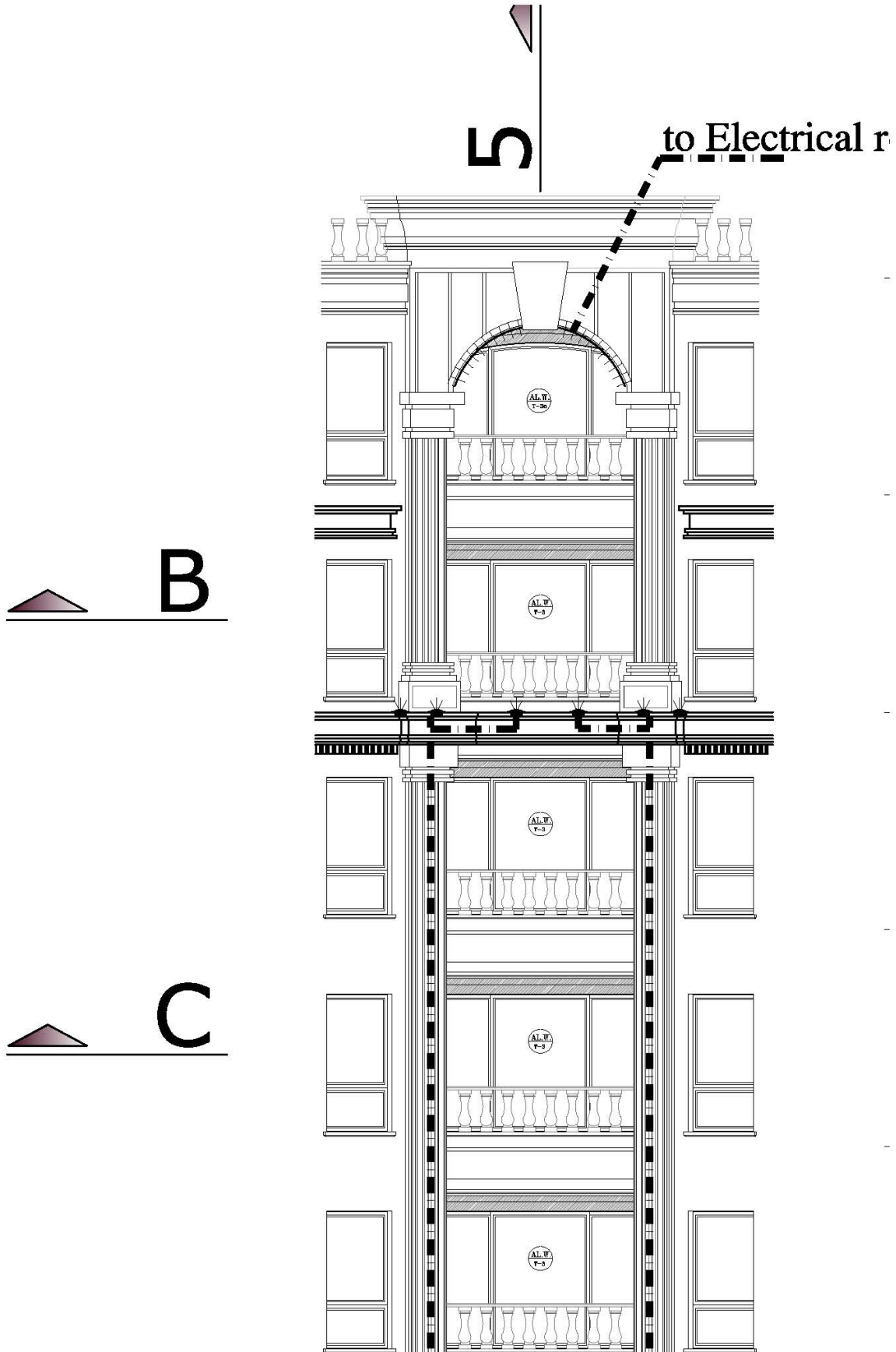

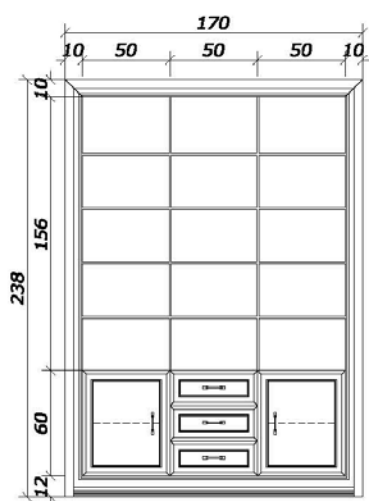
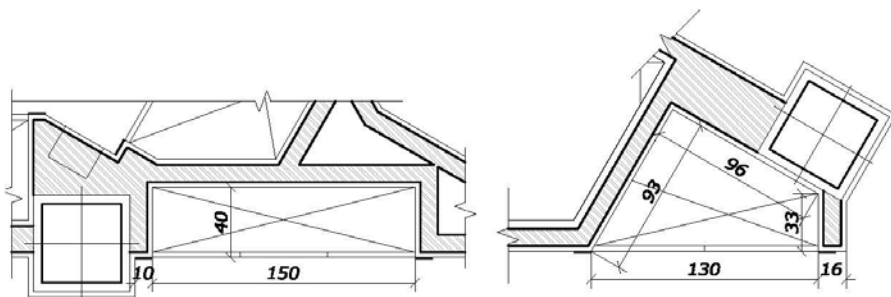

E-13-2
Sc:1/25

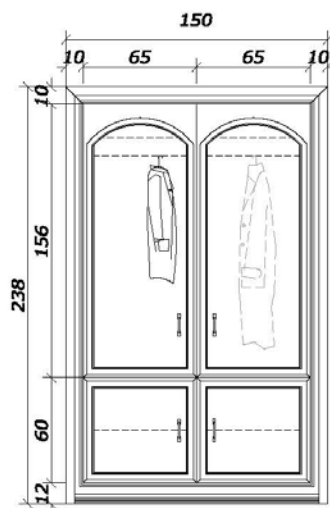

E-13-1
Sc:1/25

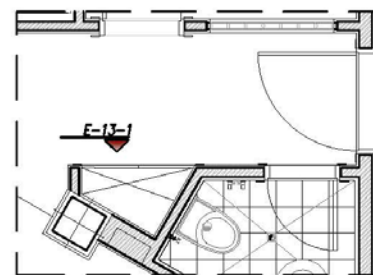

پلان یزرگنمایی کمد ورودی

Sc:1/25

کب طبقات ۲۴۹

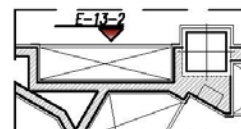

پلان یزرگنمایی کمد پذیرایی

Sc:1/25

کب طبقات ۹۴۹

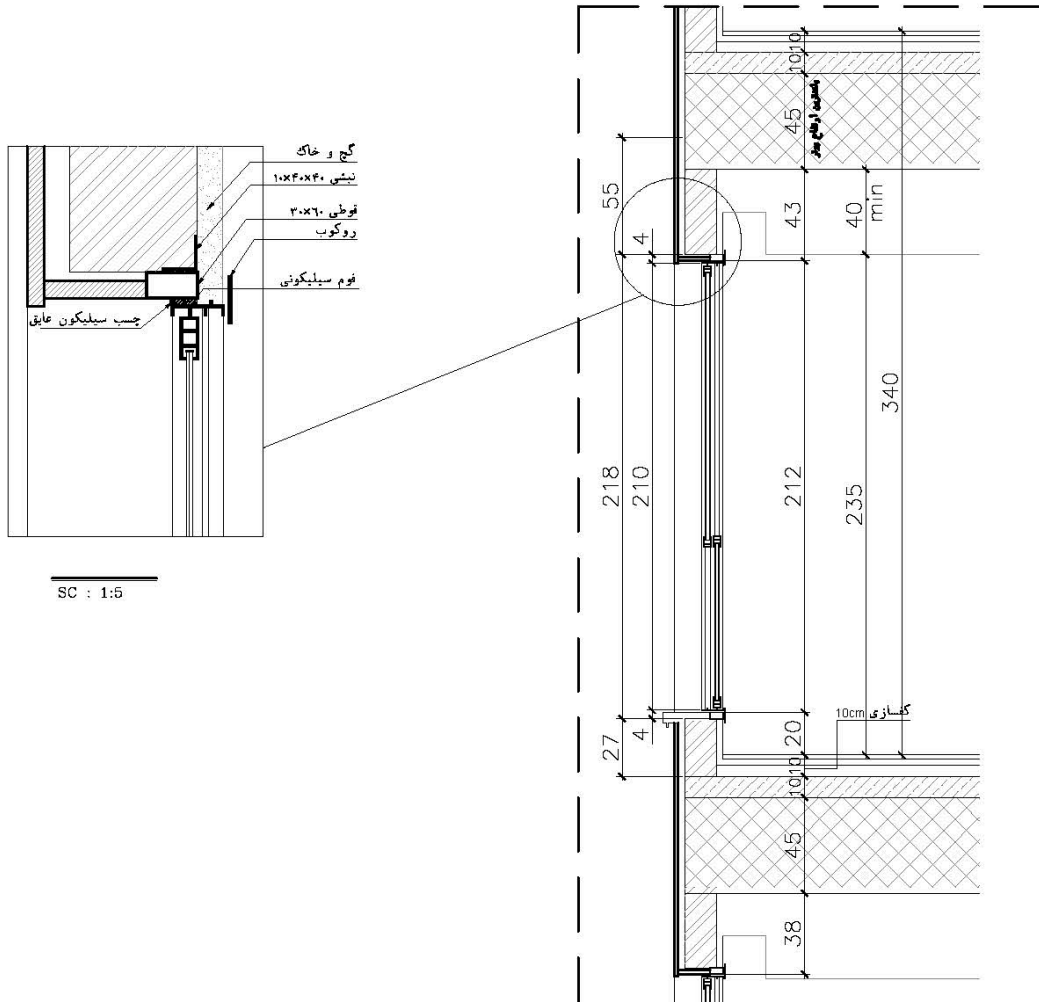

برش عمودی از پنجره

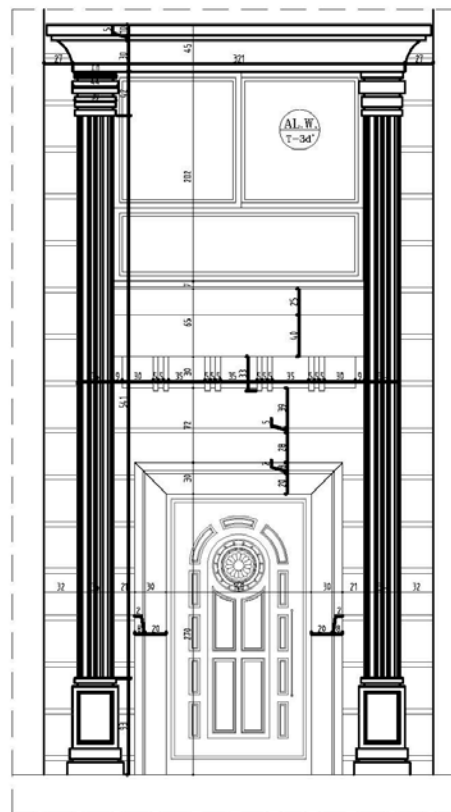

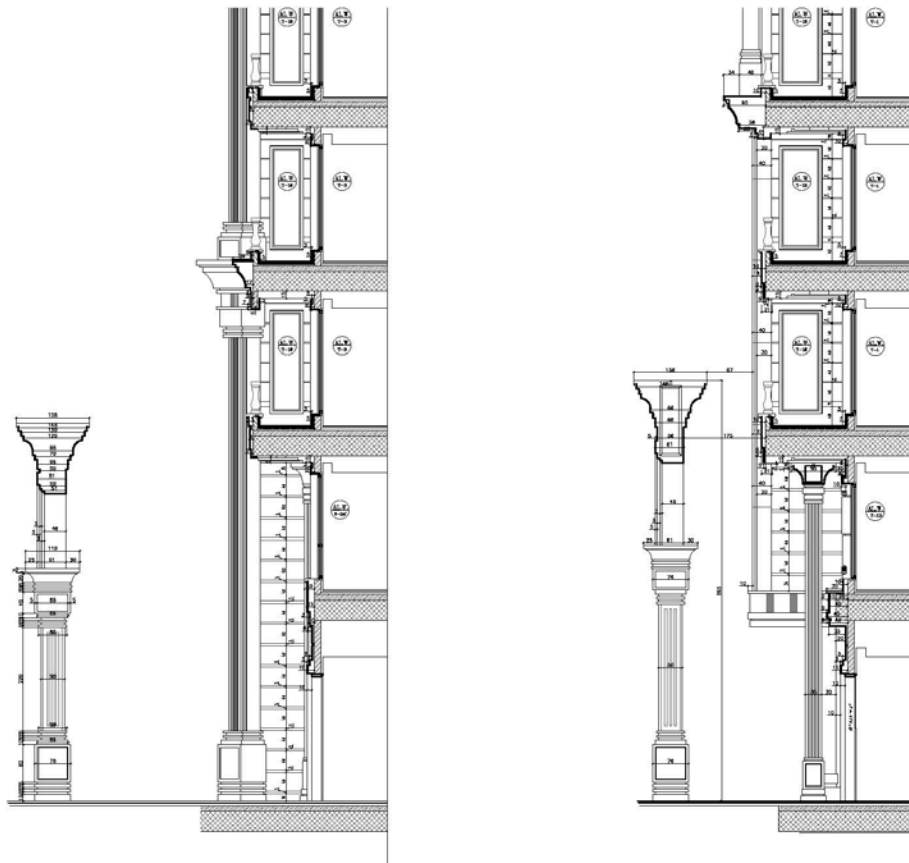

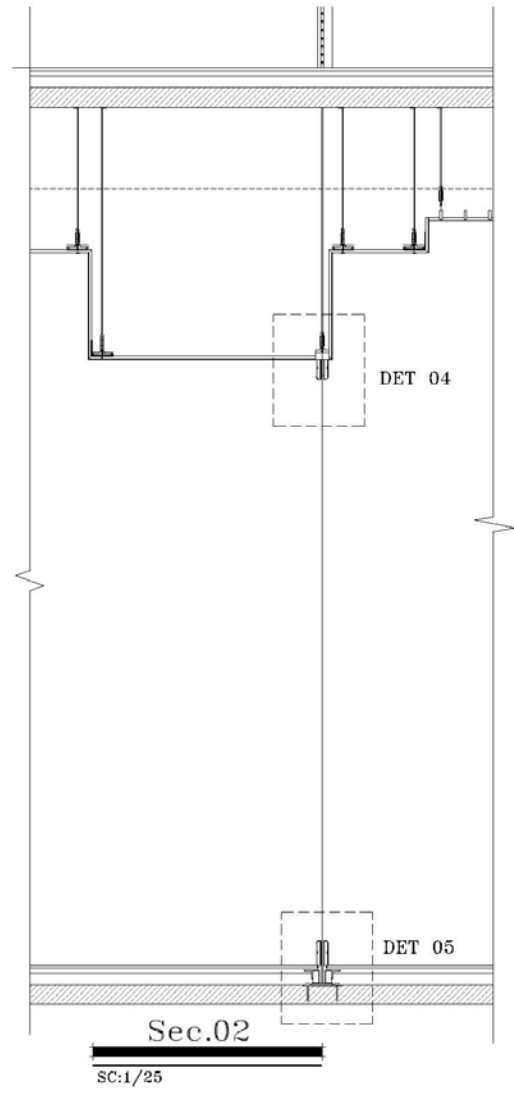
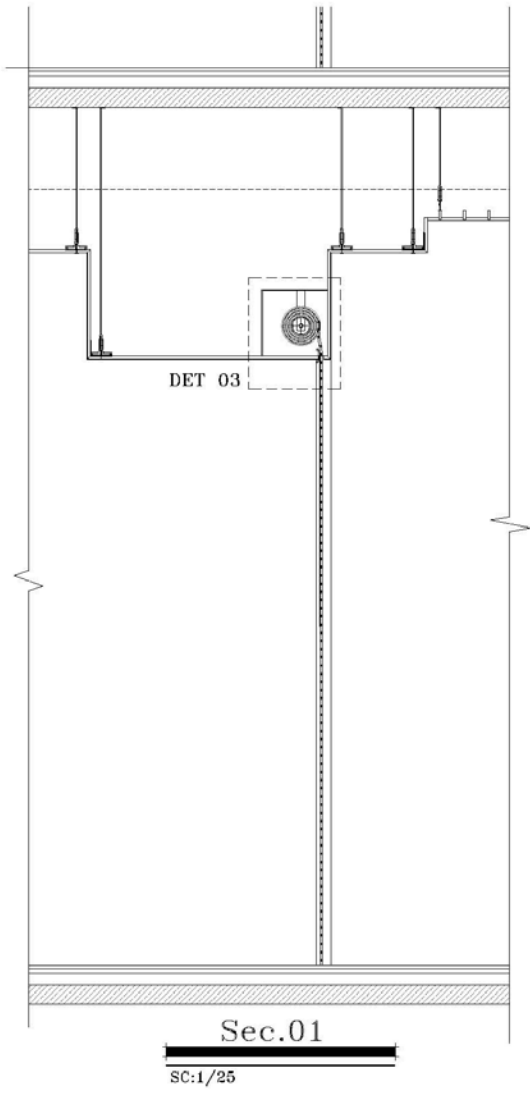

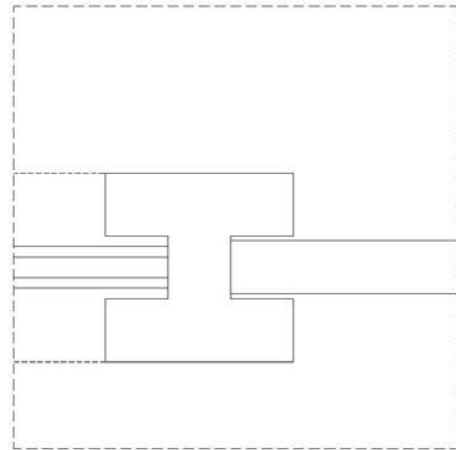
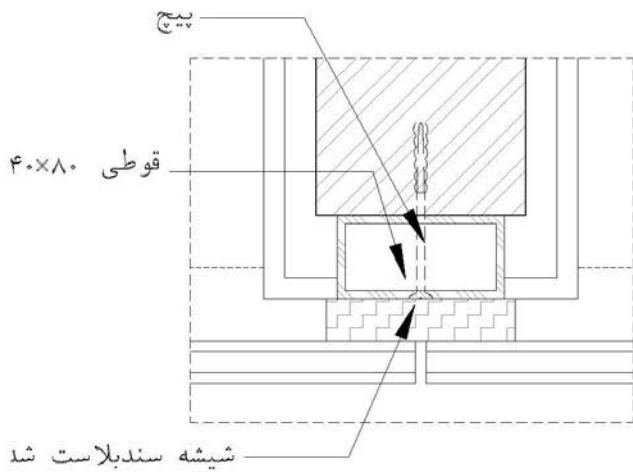
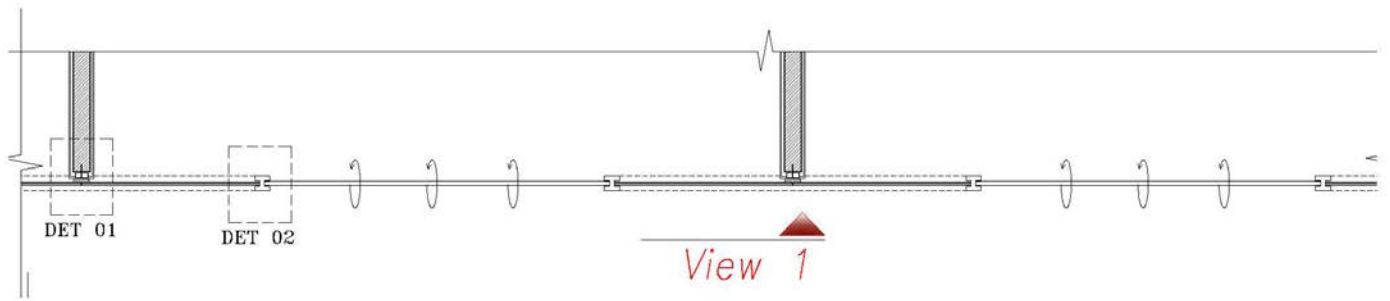

Det.01
SC:1/20

Det.02
SC:1/20

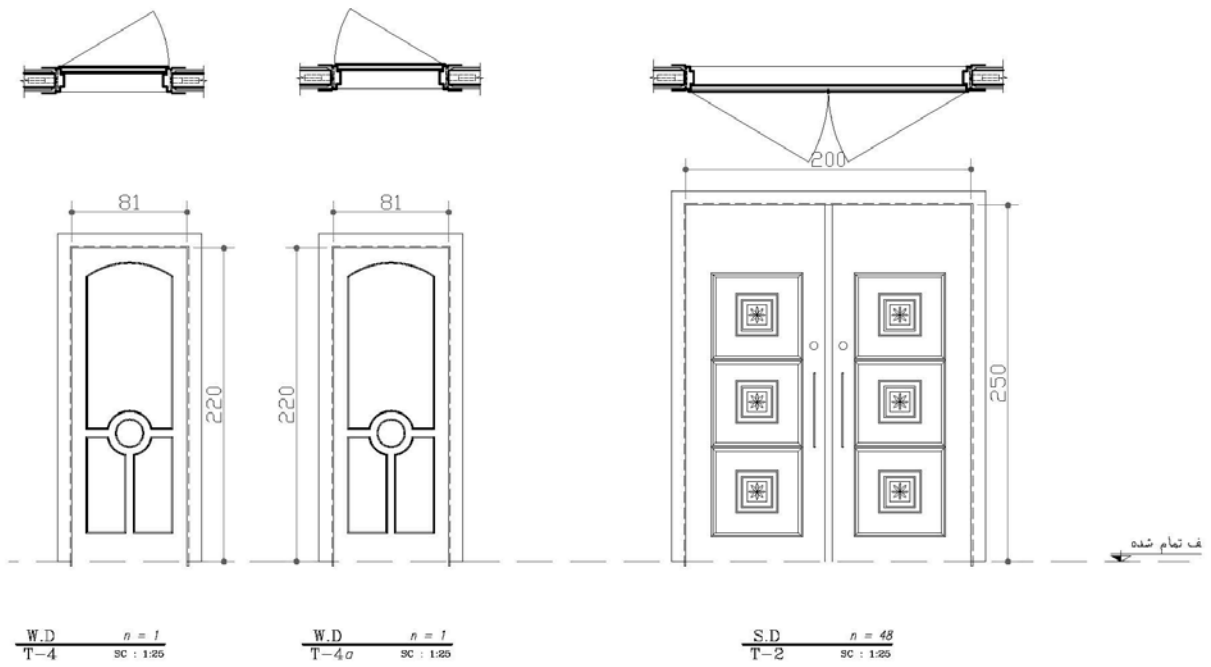

• درب با منوی MDF با روکش PVC متبران مغلفه طرح صدف شرکت ناسازان نسر با رنگه مالمکونی.

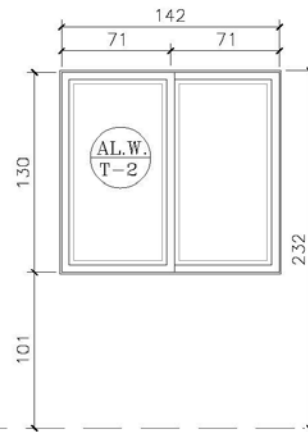
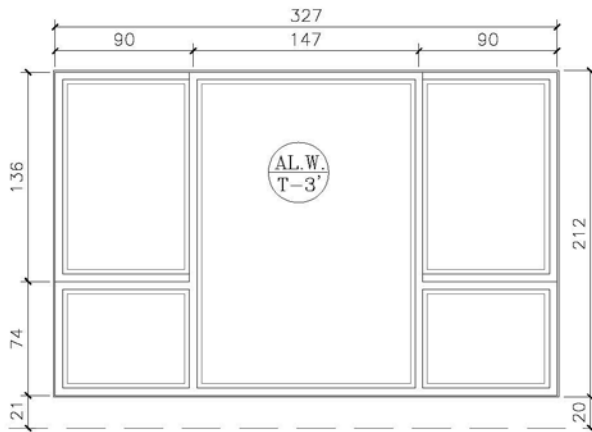
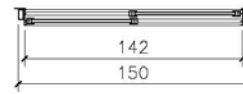
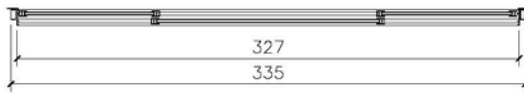

کف تمام شده

AL.W. n = 14
T-3' SC : 1.25

AL.W. n = 8
T-2' SC : 1.25

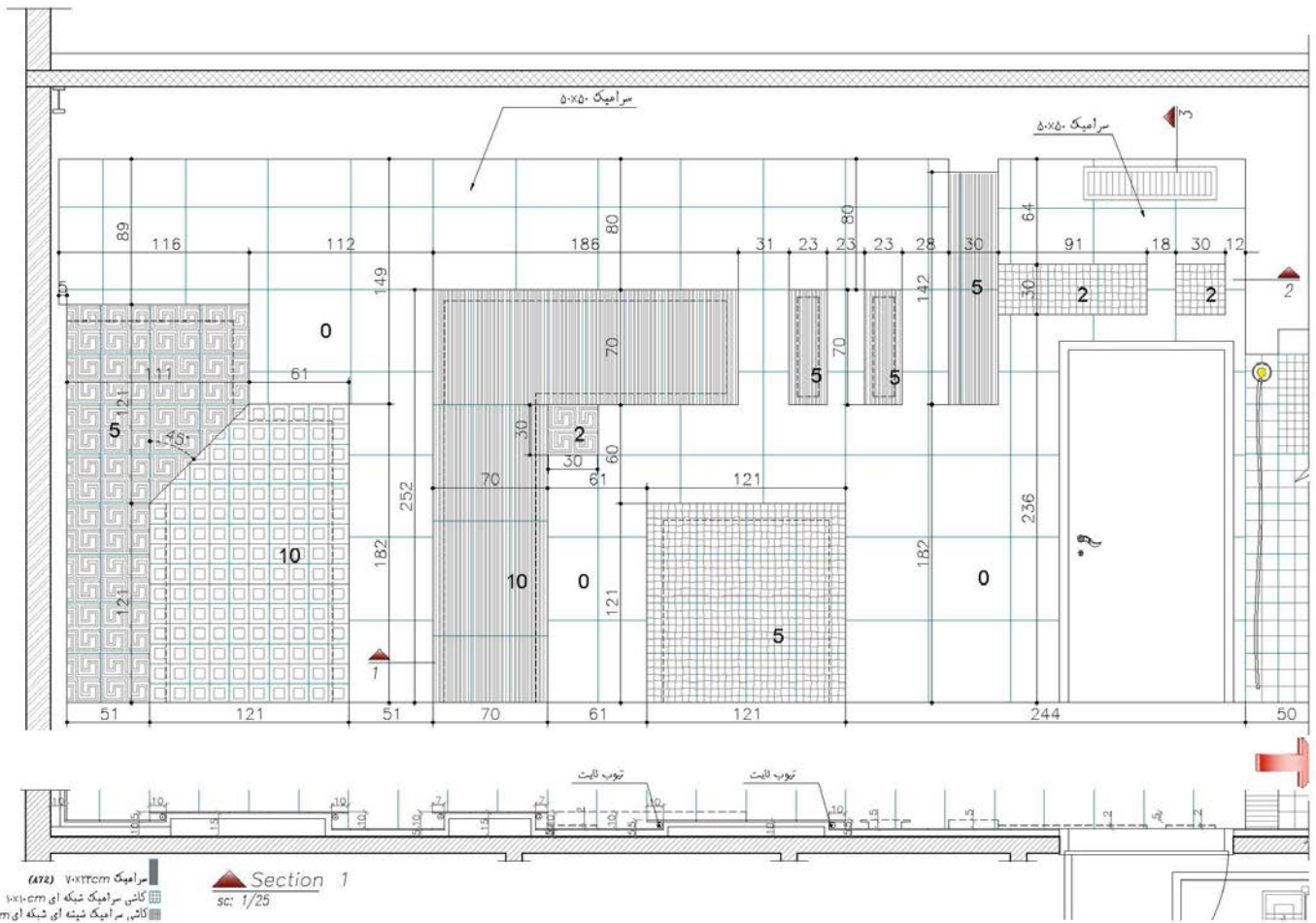



نمونه رندرهای داخلی پروژه های طراحی شده













